

THE PROPERTY OF THE DRAWING IS ESTABLISHED BY LAW. IT IS FORBIDDEN TO PRODUCE OR SHOW IT TO THIRD PARTY, WITHOUT A WRITTEN AGREEMENT.

Item	Name	Q.ty
1	M.12X81.5	1
2	VSN.20.1.14	1
3	VSN.20.2.14	1
4	VSN.2050.2.1	1
5	VSN.2050.3	1
6	VSN.2050.4	1

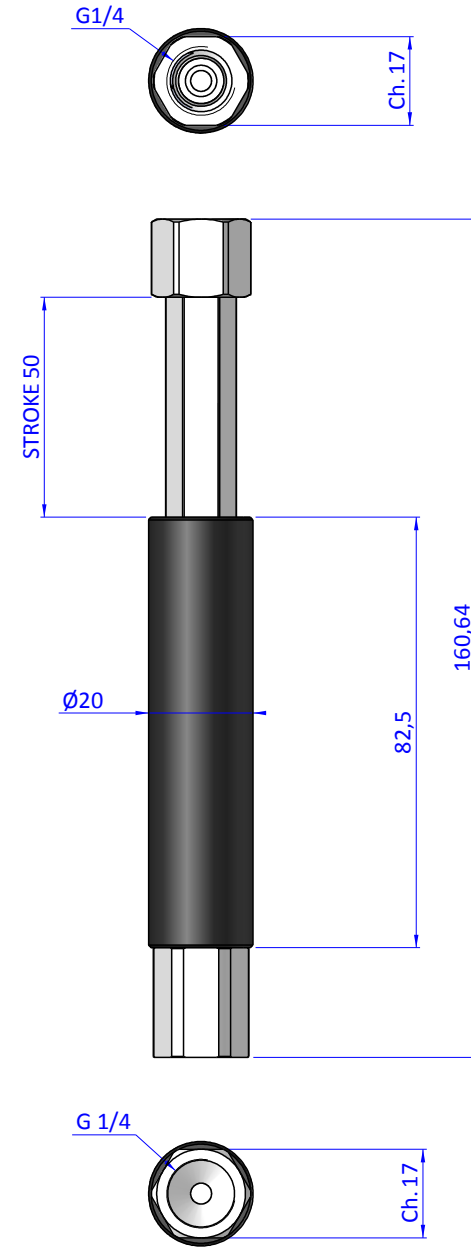
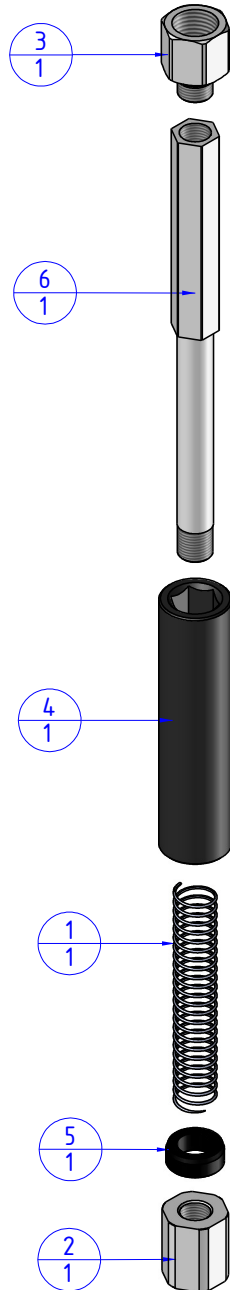

Format A3

UNI 936-76

FP SERVICES AUTOMATION		DESIGNED FROM FPSERVICES	REVIEW A
GENERAL TOLERANCE UNI - ISO 2768 CLASSE f	DESCRIPTION CA.SDN.2050.14	DATE 24/10/2018	WEIGHT 0,077kg
		CODE CA.SDN.2050.14	